



BARRIER SYSTEMS

PARKING / INDUSTRIAL / TOLL / SOLAR



HIGH QUALITY AND
TESTED SECURITY



COMFORTABLE OPERATION
AND EASY INSTALLATION



ROBUST, DURABLE
AND RELIABLE

ELKA

TABLE OF CONTENTS

Series PARKING for parking garages and car parks	Page 02 - 09
Series INDUSTRIAL for industrial solutions	Page 10 - 17
Series TOLL for toll stations	Page 18 - 23
Series SOLAR for entrances without mains connection	Page 24 - 31
Controller MO 24	Page 32 - 33
Optional modules	Page 34 - 35
Safety devices	Page 36 - 41
Access control devices	Page 42 - 43
Easy Control / ELKA ECON APP	Page 44 - 45
Pillars and housings	Page 46 - 47
Technical data	Page 48 - 55
Operation of legal and standard-compliant barriers	Page 56 - 57
ELKA Torantriebe - Partner with competence	Page 58 - 65

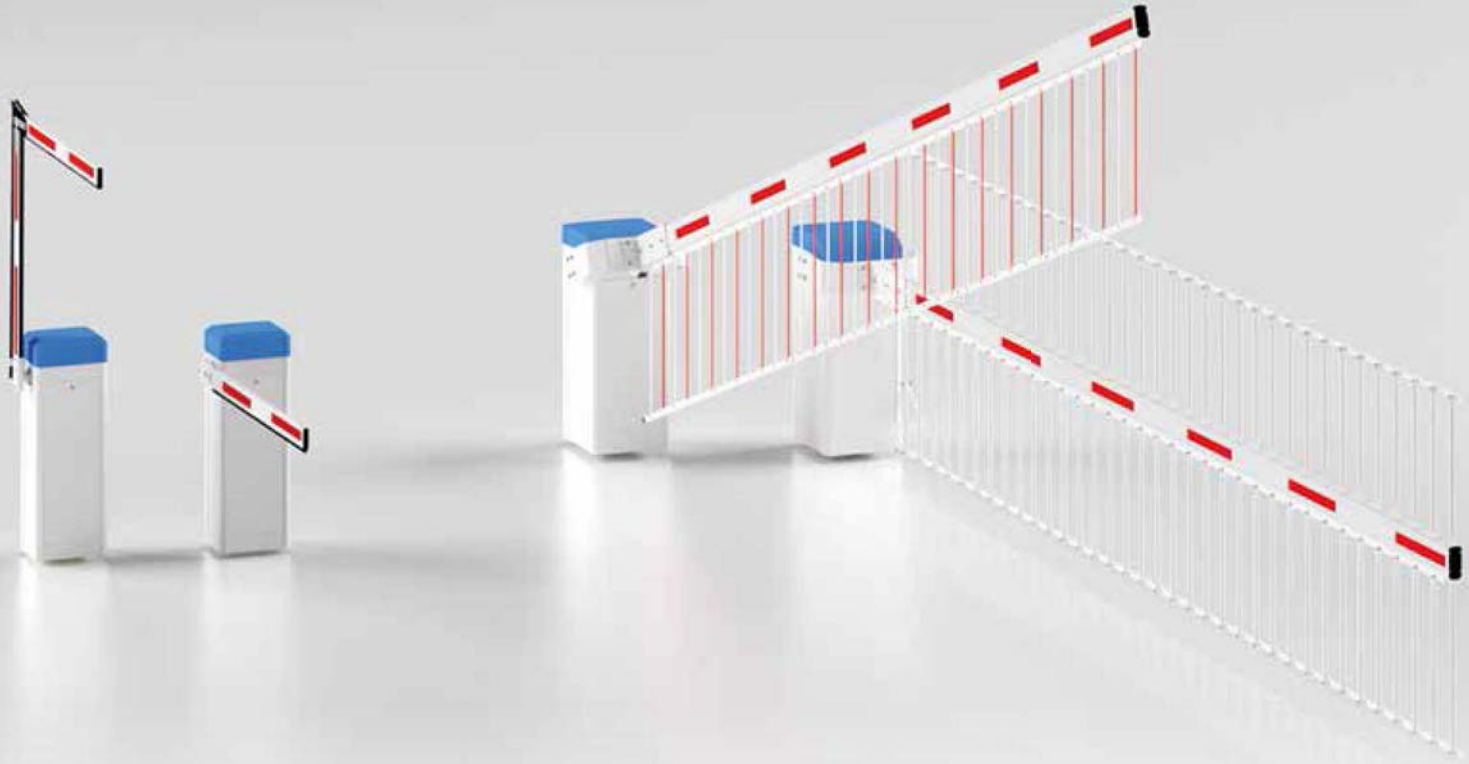

ELKA Barrier systems

ELKA offers a selection of barrier systems for parking garages, car parks and industrial entrances with different effective boom lengths and running times as well as suitable accessories for different purposes, e.g. boom lighting LED, articulation kits, folding skirts and folding top and bottom skirts and safety devices.

Perfect running performance and optimized mechanics protect motor and gear. An efficient drive concept and robust components ensure an intensive operation with 100% duty cycle.



Learn more about the safe use of ELKA barriers for the regulation of vehicle traffic in application where passenger traffic cannot be excluded and contact our competent team. We are happy to support you in planning and implementing projects and look forward to your request.

Benefit from over 40 years of experience - approx. 100,000 barriers installed in over 80 countries worldwide. All products are manufactured in Germany and are subject to strict quality controls.



Shortening of the barrier boom to the required length is free of charge



Product packaging is free of charge (barrier incl. barrier boom)



Optionally available in all RAL custom colours

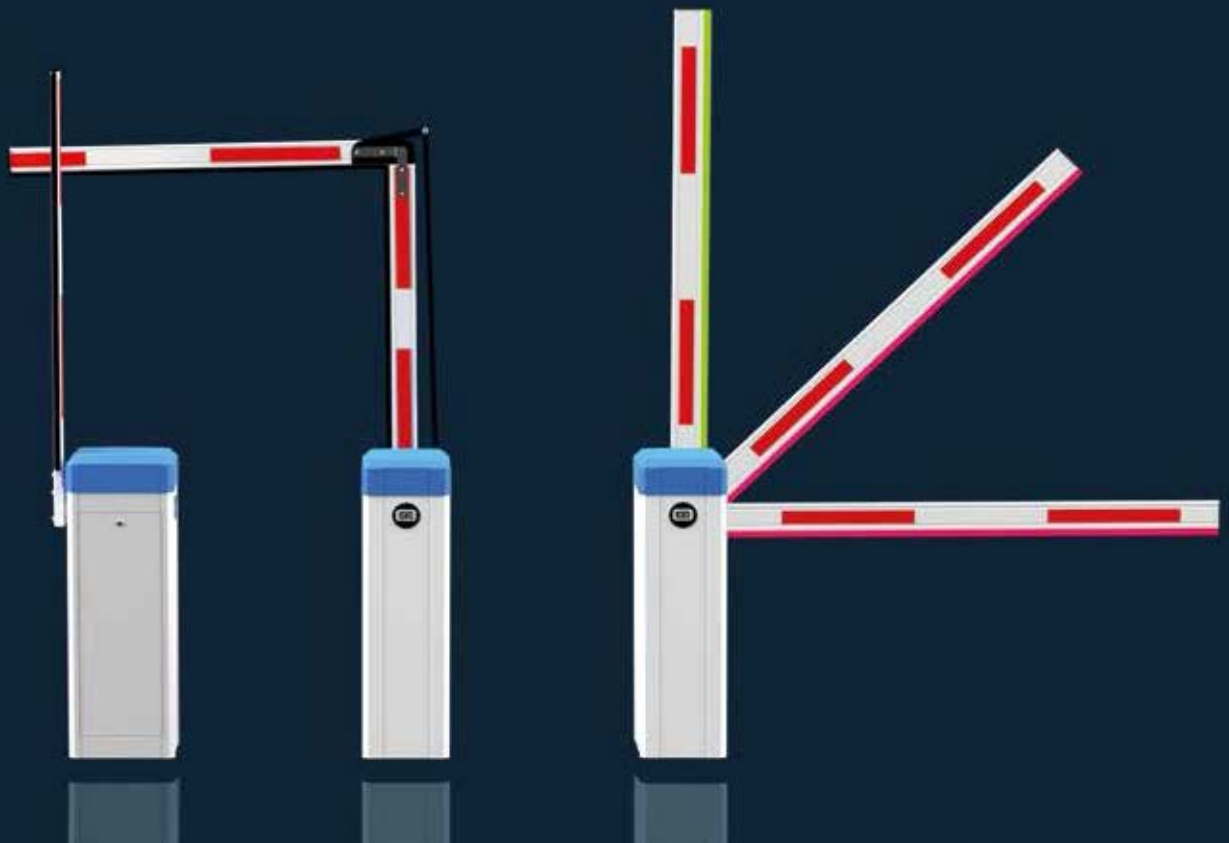

Barriers series PARKING for parking garages and car parks

ELKA barriers of the series „PARKING“ are designed for access control of parking garages and car parks. Perfect running performance, achieved by electronic speed control and optimized mechanics, protect motor and gear. An efficient drive concept with a powerful 24V BLDC-gear and robust components ensure intensive operation with 100% duty cycle.

ELKA barriers of the PARKING series are offered in two versions - EU and UL version, according to the requirements of the European Union and North America (USA, Canada).

TECHNOLOGY IN DETAIL

- **Housing hood**
simple removal,
without tools
- **24V BLDC motor / gear**
powerful, 100% duty cycle
- **Spring assembly**
for balanced barrier
movements
- **Cable bushing**
comfortable - plenty of room
- **Controller**
electronic speed control
- **Terminal row**
professional connection of
accessories



- **Barrier boom**
left / right usable
- **Emergency release**
fast and simple
- **Robust mechanics**
for intensive use,
with vandalism protection
- **Power supply**
IP68, high efficiency ratio
- **Top-hat rail**
Space for additional installations
- **Barrier housing**
Aluminium, with patent
pending clamping technology



Robust mechanics

- ✓ Mechanics for intensive use up to 100% duty cycle
- ✓ Components made of galvanized steel
- ✓ Drive lever with vandalism protection



Efficient drive concept

- ✓ Energy-saving with powerful 24V BLDC motor
- ✓ Multistage planetary gear



Barrier housing

- ✓ Made of aluminium, IP 54, with patent pending clamping technology
- ✓ Powder-coated, RAL 5012/9010
- ✓ Custom colours upon request (extra charge)

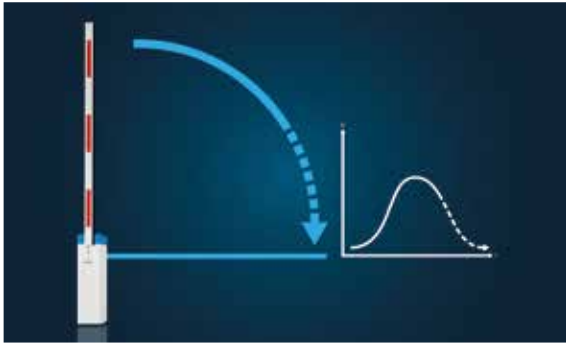

Perfect running performance

- ✓ Precise barrier boom movement through electronic rotation speed control
- ✓ Fast, quiet, smooth
- ✓ Opening limitation 55° - 90° (in 5°-steps)



Power reversal

- ✓ Power reversal upon encountering an obstacle



Comfortable service

- ✓ For the safety of the service technician:
service switch deactivates all external operating commands
- ✓ Service power outlet for convenient working on-site
(not for UL version)

BARRIER BOOM

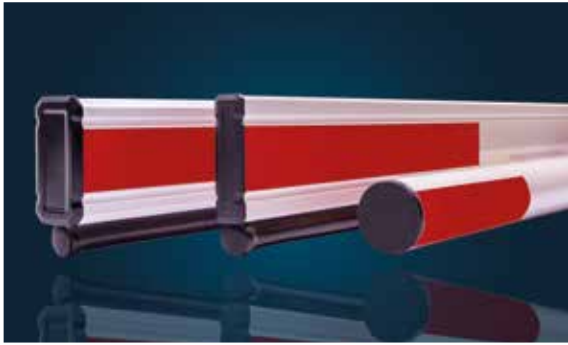

Barrier boom

- ✓ Made of aluminium
- ✓ With red reflective signal stripes
- ✓ Rubber tube on the boom underside
- ✓ Pre-assembled



Boom connection

- ✓ Left / right usable
- ✓ Boom connector for profile or round barrier boom

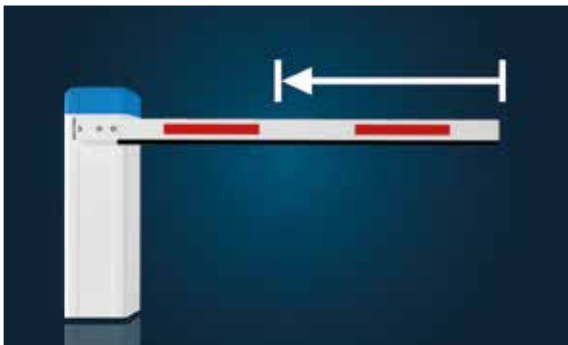

Shortening of the barrier boom

- ✓ The shortening of the barrier boom to the required length is free of charge



Boom lighting LED

- ✓ Individual configuration
- ✓ Pre-assembled or for on-site installation
- ✓ Lighting colour in red or green



Boom lighting LED on the underside

- ✓ Uniform illumination of the entire barrier boom length
- ✓ Translucent rubber tube
- ✓ Up to a barrier boom length of 5,000mm, can be shortened as required



Fixed and swinging support

- ✓ Made of aluminium
- ✓ Powder-coated, RAL 9010
- ✓ Height adjustable (without illustration)
- ✓ Fixed support with electromagnet (without illustration)

ARTICULATION KIT

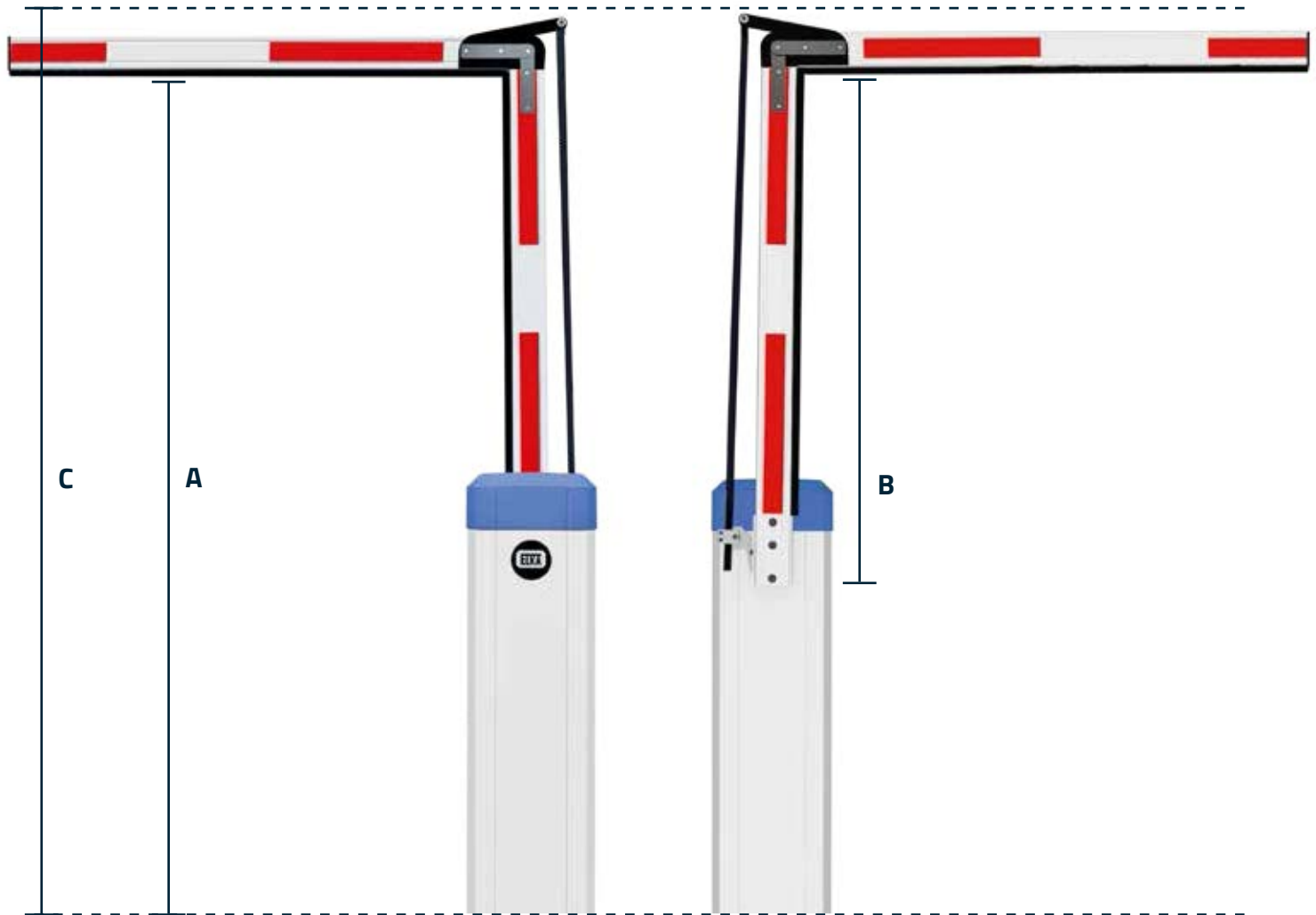

A = Clearance height (max. 2,250mm)

B = Boom length, first part (A - 830mm, max. 1,420mm)

C = Ceiling height (A + 185mm)

Available as a set or pre-assembled on the barrier boom (max. boom length 4,000mm).

CUSTOM COLOURS



Optionally available in all RAL custom colours (extra charge).

Standard colours: barrier housing white / RAL 9010, housing hood blue / RAL 5012



Barriers series INDUSTRIAL for industrial solutions

ELKA barriers of the series „INDUSTRIAL - series S“ are designed for the protection of industrial entrances and can be operated with folding skirts and folding top and bottom skirts. Perfect running performance, achieved by electronic speed control and optimized mechanics, protect motor and gear. An efficient drive concept and robust components ensure intensive operation with 100% duty cycle.

ELKA offers a selection of 3 barrier types of this series with different effective boom lengths and running times as well as suitable accessories for different purposes.

ELKA barriers of the INDUSTRIAL series are offered in two versions - EU and UL version, according to the requirements of the European Union and North America (USA, Canada).



TECHNOLOGY IN DETAIL

- **Housing hood**
simple removal,
without tools
- **24V BLDC motor / gear**
powerful, 100% duty cycle
- **Spring assembly**
for balanced barrier
movements
- **Cable bushing**
comfortable - plenty of room
- **Controller**
electronic speed control,
can be swung out to the side
- **Terminal row**
professional connection of
accessories



- **Barrier boom**
middle boom connector,
left / right usable
- **Emergency release**
fast and simple
- **Robust mechanics**
for intensive use,
with vandalism protection
- **Power supply**
IP68, high efficiency ratio
- **Top-hat rail**
Space for additional installations
- **Barrier housing**
Aluminium, with patent
pending clamping technology



Robust mechanics

- ✓ Mechanics for intensive use up to 100% duty cycle
- ✓ Components made of galvanized steel
- ✓ Drive lever with vandalism protection



Efficient drive concept

- ✓ Energy-saving with powerful 24V BLDC gear
- ✓ Multistage planetary gear



Barrier housing

- ✓ Made of aluminium, IP 54, with patent pending clamping technology
- ✓ Powder-coated, RAL 5012/9010
- ✓ Custom colours upon request (extra charge)

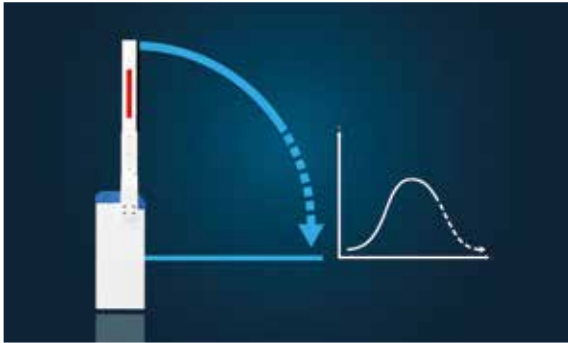

Perfect running performance

- ✓ Precise barrier boom movement through electronic rotation speed control
- ✓ Fast, quiet, smooth



Power reversal

- ✓ Power reversal upon encountering an obstacle



Comfortable service

- ✓ For the safety of the service technician:
service switch deactivates all external operating commands,
locking of the mechanism during change of the springs
- ✓ Service power outlet for convenient working on-site

BARRIER BOOM

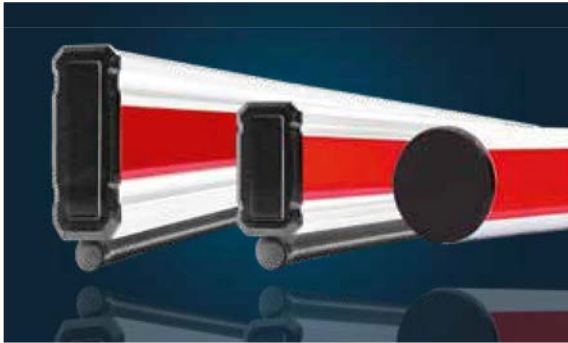

Barrier boom

- ✓ Made of aluminium
- ✓ With red reflective signal stripes
- ✓ Rubber tube on the boom underside
- ✓ Pre-assembled



Boom connection

- ✓ Middle boom connector
- ✓ Left / right usable
- ✓ Boom connector for profile or round barrier boom

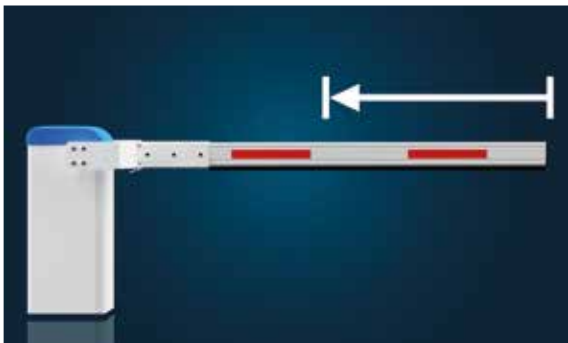

Shortening of the barrier boom

- ✓ The shortening of the barrier boom to the required length is free of charge



Boom lighting LED

- ✓ Individual configuration
- ✓ Pre-assembled or for on-site installation
- ✓ Lighting colour in red or green

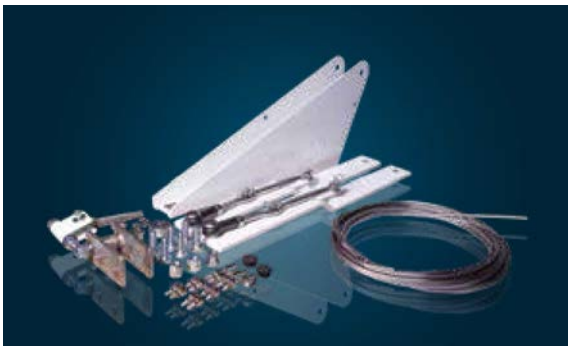

Articulation kit

- ✓ Available as a set (upon request)
- ✓ Max. boom length 6,000mm



Fixed and swinging support

- ✓ Made of aluminium
- ✓ Powder-coated, RAL 9010
- ✓ Height adjustable (without illustration)
- ✓ Fixed support with electromagnet (without illustration)

FOLDING SKIRTS AND FOLDING TOP AND BOTTOM SKIRTS (ALUMINIUM)



Folding skirt HG75 (S 5000 / S 6000 / S 8000)

- ✓ Height 750mm
- ✓ Colour red / white
- ✓ Incl. spacer and guide plate for swinging support
- ✓ Max. boom length 8,000mm
- ✓ Pre-assembled for on-site installation



Folding skirt HG150 (S 6000 / S 8000)

- ✓ Height 1,500mm
- ✓ Colour white
- ✓ Incl. guide bar, spacer and guide plate for swinging support
- ✓ Max. boom length 6,000mm
- ✓ Pre-assembled for on-site installation



Folding top and bottom skirt SG150 (S 6000 / S 8000)

- ✓ Height 1,500mm
- ✓ Colour white
- ✓ Incl. guide lever and spacer
- ✓ Max. boom length 6,000mm
- ✓ Pre-assembled for on-site installation

CUSTOM COLOURS



Optionally available in all RAL custom colours (extra charge).

Standard colours: barrier housing white / RAL 9010, housing hood blue / RAL 5012



Barriers series TOLL for toll stations

ELKA barriers of the series „TOLL“ are designed for toll stations. Short running times starting at approx. 0.3 seconds ensure an optimal traffic flow. Perfect running performance, achieved by electronic speed control and optimized mechanics, protect motor and gear. An efficient drive concept with a powerful 24V BLDC-motor and robust components ensure intensive operation with 100% duty cycle.

A clip-out function prevents collision damage to the barrier boom by folding it to the side. This enables short-term operation, without lengthy lane failure, even by untrained personnel.

ELKA barriers of the TOLL series are offered in two versions - EU and UL version, according to the requirements of the European Union and North America (USA, Canada).

TECHNOLOGY IN DETAIL

- **Housing hood**
simple removal,
without tools
- **24V BLDC motor / gear**
powerful, 100% duty cycle
- **Spring assembly**
for balanced barrier
movements
- **Cable bushing**
comfortable - plenty of room
- **Controller**
electronic speed control
- **Terminal row**
professional connection of
accessories

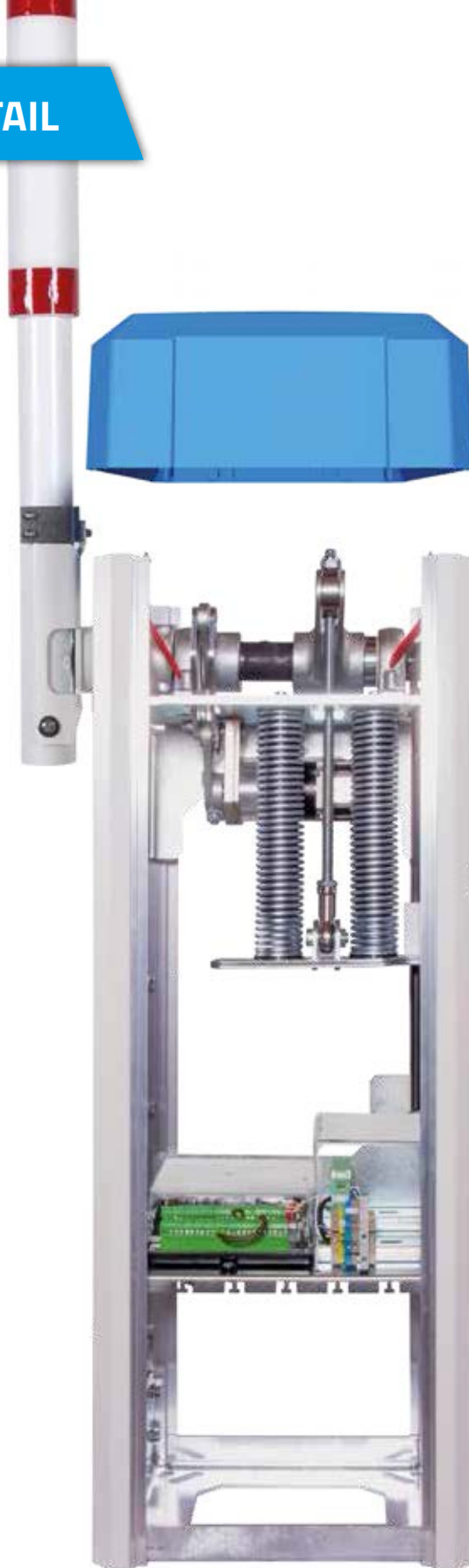

- **Barrier boom**
round boom with soft protect,
left / right usable
- **Clip-out function**
folding the barrier boom to the
side (up to 90°)
- **Robust mechanics**
for intensive use
- **Power supply**
IP68, high efficiency ratio
- **Top-hat rail**
Space for additional installations
- **Barrier housing**
Aluminium, with patent
pending clamping technology



Robust mechanics

- ✓ Mechanics for intensive use up to 100% duty cycle
- ✓ Components made of galvanized steel
- ✓ Drive lever with vandalism protection

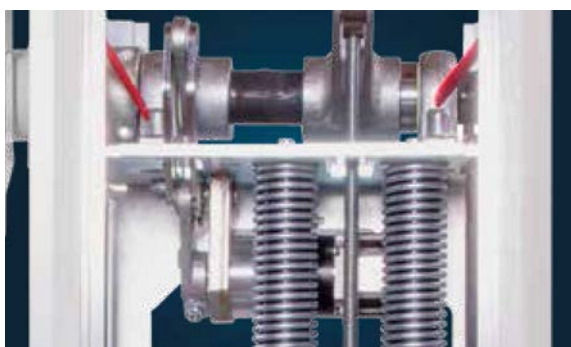

Efficient drive concept

- ✓ Energy-saving with powerful 24V BLDC motor
- ✓ Multistage planetary gear



Barrier housing

- ✓ Made of aluminium, IP 54, with patent pending clamping technology
- ✓ Powder-coated, RAL 5012/9010
- ✓ Custom colours upon request (extra charge)

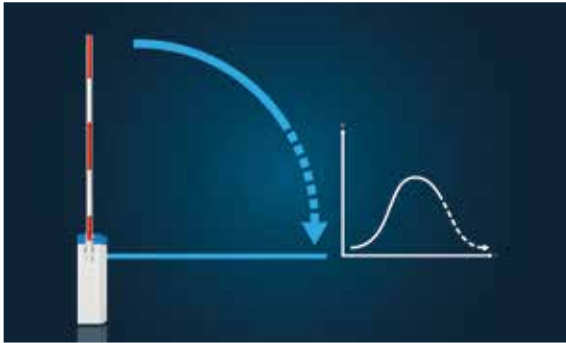

Perfect running performance

- ✓ Precise barrier boom movement through electronic rotation speed control
- ✓ Fast, quiet, smooth



Comfortable service

- ✓ For the safety of the service technician:
service switch deactivates all external operating commands

Barriers of the series TOLL ensure an optimal traffic flow through particularly short running times starting at approx. 0.3 seconds.

BARRIER BOOM



Barrier boom

- ✓ Made of aluminium
- ✓ With soft protect (waterproofed foam-covering)
- ✓ With red reflective signal stripes
- ✓ Pre-assembled



Boom connection with clip-out function

- ✓ Left / right usable
- ✓ Folding the barrier boom to the side (up to 90°)
- ✓ Prevents collision damage

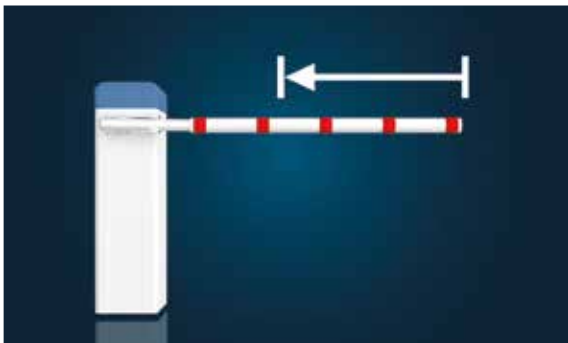

Shortening of the barrier boom

- ✓ The shortening of the barrier boom to the required length is free of charge

CUSTOM COLOURS

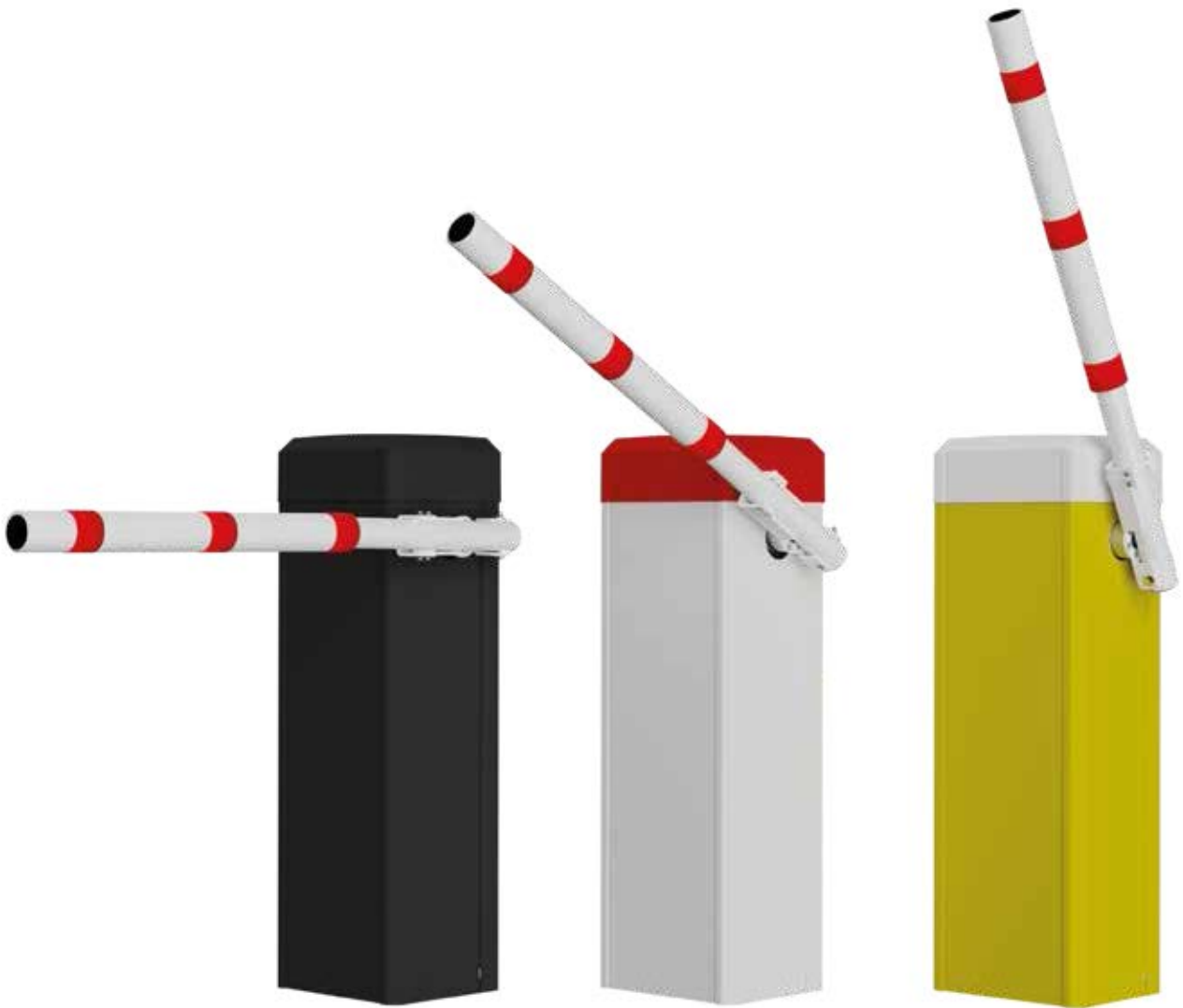

Optionally available in all RAL custom colours (extra charge).

Standard colours: barrier housing white / RAL 9010, housing hood blue / RAL 5012

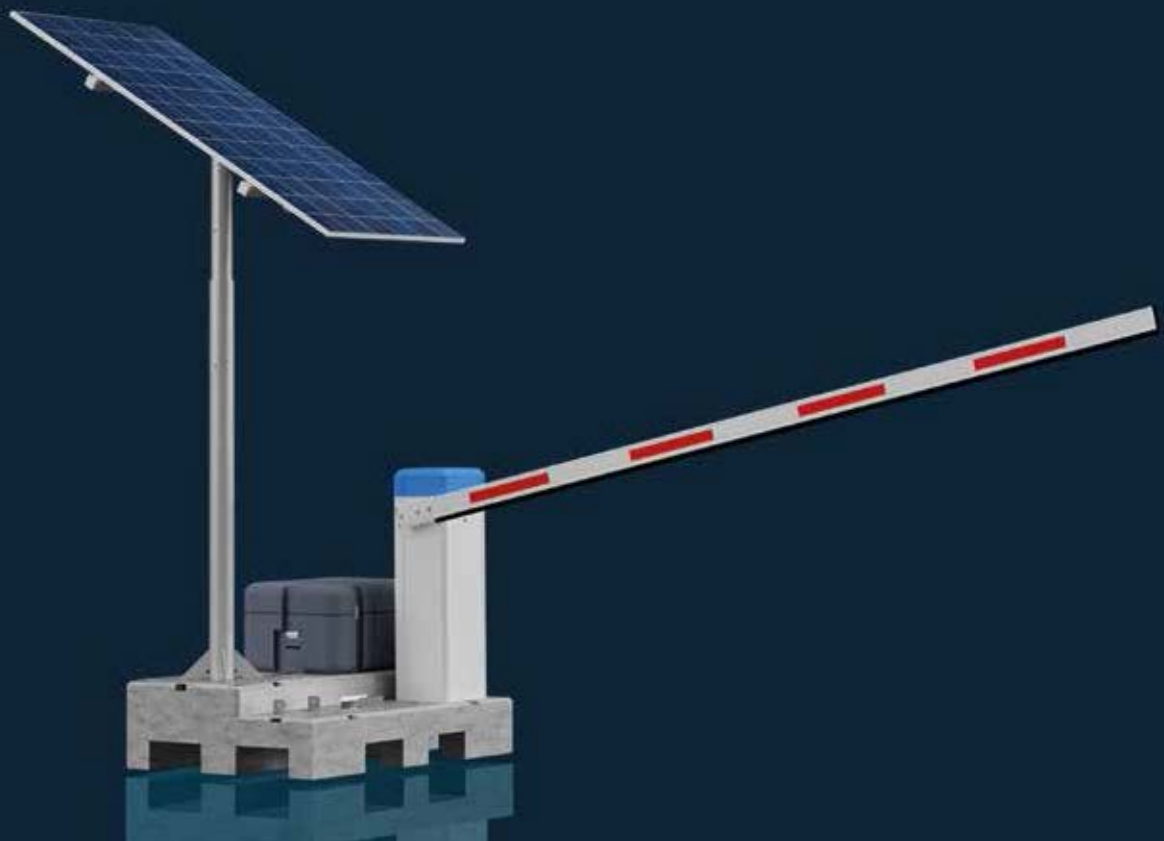

Barriers series SOLAR for entrances without mains connection

ELKA solar barriers are available in two versions. Mobile - for temporary use at construction sites or event locations. Stationary - for long-term use at car parks or entrances without mains connection. Perfect running performance, achieved by electronic speed control and optimized mechanics, protect motor and gear.

An efficient drive concept with a powerful 24V BLDC-motor and robust components ensure a long life cycle. With little solar radiation, the battery charge is sufficient for approx. 7 days with 500 cycles per day.

ELKA barriers of the SOLAR series fulfill the requirements of the European Union.

TECHNOLOGY IN DETAIL

- **Housing hood**
simple removal,
without tools
- **24V BLDC motor / gear**
powerful, 100% duty cycle
- **Spring assembly**
for balanced barrier
movements
- **Cable bushing**
comfortable - plenty of room
- **Controller**
electronic speed control
- **Terminal row**
professional connection of
accessories



- **Barrier boom**
left / right usable
- **Emergency release**
fast and simple
- **Robust mechanics**
for intensive use,
with vandalism protection
- **Independent power supply**
Operation via solar module
and batteries
- **Top-hat rail**
Space for additional installations
- **Barrier housing**
Aluminium, with patent
pending clamping technology

VARIANTS



Mobile solar barrier

Mobile, network-independent solar barrier for temporary access control at construction sites or event locations. The barrier is prepared ready for use ex factory - all components are loaded in a space-saving way on a mobile concrete foundation and can be easily and quickly assembled. If required, the batteries can be recharged via an optional battery charger before each use. On-site the barrier operates via solar module and long-lasting batteries.

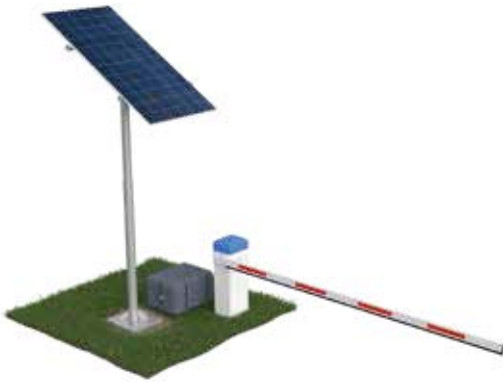

Stationary solar barrier

Mains-independent solar barrier for car parks or access roads without existing mains power connection. Solar module, outdoor battery box and solar barrier can be placed independently of each other. Thus, the solar module can be set up at a sunny place, while the barrier is installed on the shady driveway.



Custom colours

Optionally available in all RAL custom colours (extra charge). Standard colours: barrier housing white / RAL 9010, housing hood blue / RAL 5012.



Robust mechanics

- ✓ Mechanics for intensive use up to 100% duty cycle
- ✓ Components made of galvanized steel
- ✓ Drive lever with vandalism protection



Efficient drive concept

- ✓ Energy-saving with powerful 24V BLDC motor
- ✓ Multistage planetary gear



Barrier housing

- ✓ Made of aluminium, IP 54, with patent pending clamping technology
- ✓ Powder-coated, RAL 5012/9010
- ✓ Custom colours upon request (extra charge)

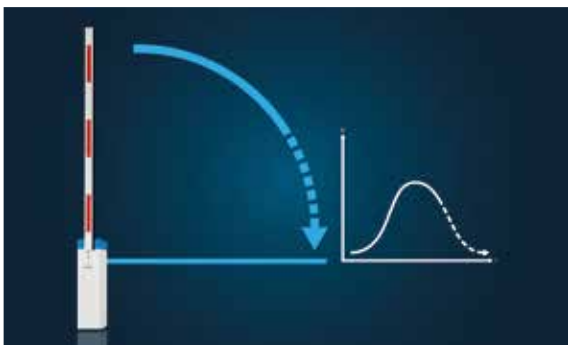

Perfect running performance

- ✓ Precise barrier boom movement through electronic rotation speed control
- ✓ Fast, quiet, smooth
- ✓ Opening limitation 55° - 90° (in 5°-steps)



Independent power supply

- ✓ Operation via solar module and batteries



Operation without sunshine

- ✓ Approx. 7 days with 500 cycles per day



Ecological

- ✓ Saves energy costs
- ✓ Autonomous use without connection to the power supply



Solar module and solar charge controller

- ✓ 72 solar cells
- ✓ Output 195Wp, nominal voltage 24V
- ✓ With depth discharge protection
- ✓ Stand made of galvanized steel



Outdoor battery box

- ✓ Lockable
- ✓ With 2 batteries (each 150Ah, 12V)
- ✓ Dimensions (w/d/h) 580 x 480 x 390 mm
- ✓ Professional ventilation

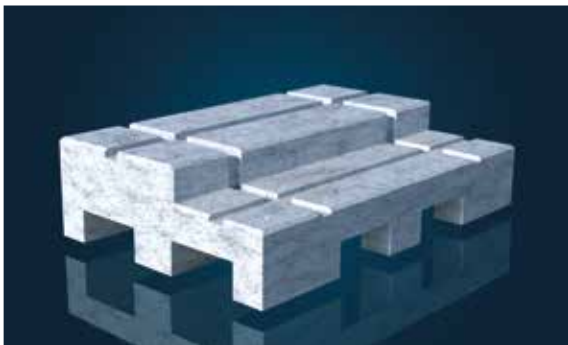

Mobile concrete foundation

- ✓ In Euro-pallet dimensions (w/d) 1,200 x 800mm
- ✓ Made of high-quality concrete (used for bridge parapets)



Charger 230V AC

- ✓ Efficiency of 94%
- ✓ Charging current max. 8A
- ✓ Nominal voltage 24V DC
- ✓ Adaptive 6-stage charging algorithm

BARRIER BOOM



Barrier boom

- ✓ Made of aluminium
- ✓ With red reflective signal stripes
- ✓ Rubber tube on the boom underside
- ✓ Pre-assembled



Boom connection

- ✓ Left / right usable
- ✓ Boom connector for profile boom

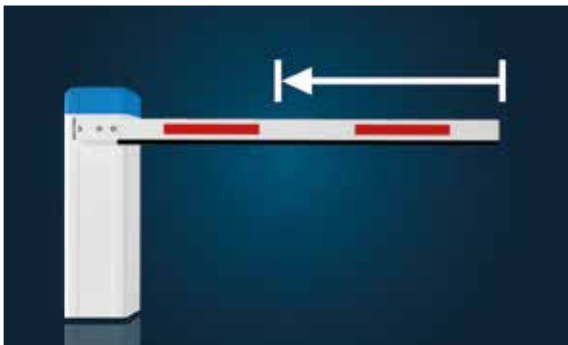

Shortening of the barrier boom

- ✓ The shortening of the barrier boom to the required length is free of charge



Boom lighting LED

- ✓ Individual configuration
- ✓ Pre-assembled or for on-site installation
- ✓ Lighting colour in red or green



Fixed and swinging support

- ✓ Made of aluminium
- ✓ Powder-coated, RAL 9010
- ✓ Height adjustable (without illustration)
- ✓ Fixed support with electromagnet (without illustration)
- ✓ Only for stationary solar barrier

The barrier boom is delivered as standard in two parts. For on-site installation the necessary accessories are supplied.

CONTROLLER MO 24



ELKA

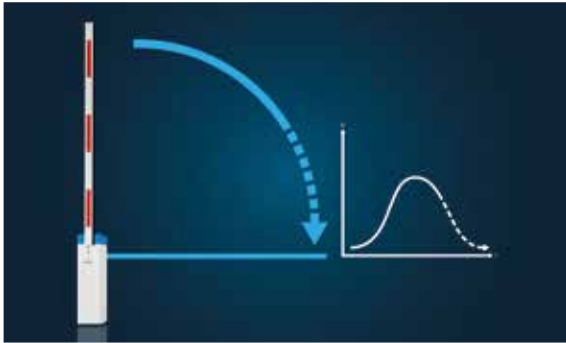

Perfect running performance

- ✓ Electronic rotation speed control
- ✓ Automatic closure (Programmable 0-655s)



Easy operation

- ✓ 4x7-segment-display
- ✓ Easy menu navigation
- ✓ Fast analysis via LEDs at the inputs



Safety

- ✓ Power reversal
- ✓ Dead man's mode
- ✓ Service switch
- ✓ Running time control
- ✓ Integrated photoelectric barrier test



Comfortable

- ✓ 3 integrated 1-channel loop detectors
- ✓ Position detection without limit switch
- ✓ 6 multifunctional relays (expandable to 14)
- ✓ Signal contact „boom missing“ evaluation
- ✓ Connections for up to 6 photoelectric barriers



Automatic opening

- ✓ Automatic opening in case of power failure



24V loading module

- ✓ Uninterrupted barrier operation in case of a power failure
- ✓ Overcharge and deep discharge protection



Multifunctional relay AMR8/AMR4

- ✓ AMR8: 8 additional multifunctional relays with function as normally open (230VAC or 120VAC / max. 120W, 24V / max. 1A)
- ✓ AMR4: 4 additional multifunctional relays, 3 with function as normally open, 1 with function as changeover contact (24V / 4A)

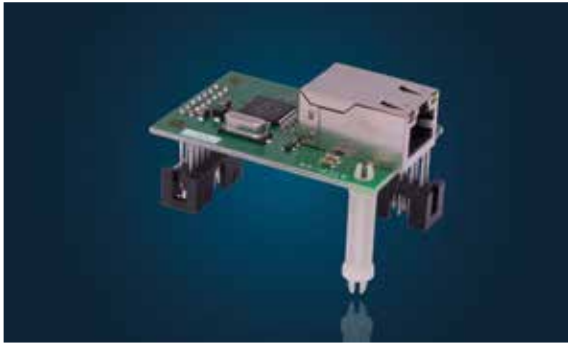

Network compatible

- ✓ TCP/IP
- ✓ Communication independent of location



Radio remote control receiver

- ✓ 434 MHz or 868 MHz
- ✓ For very good range

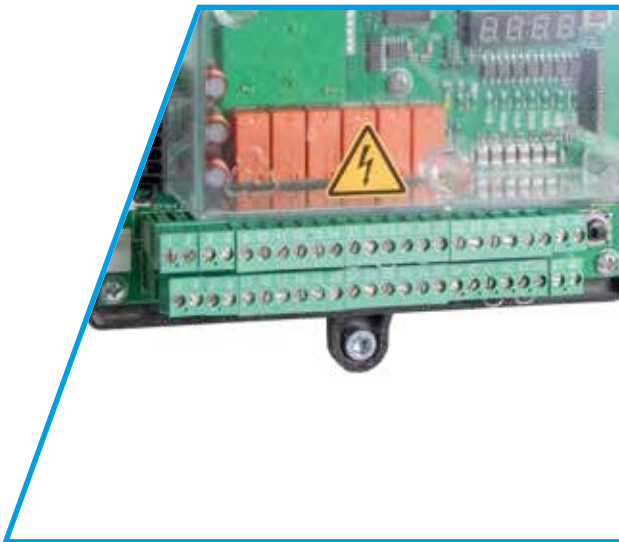

Convenient connection options

- ✓ With prewired terminal row
- ✓ Output voltages for external consumers (24Vdc, max. 1500mA, 12Vdc, max. 500mA)
- ✓ Induction loops directly connectable
- ✓ Inputs for external operating commands
- ✓ Outputs for various additional functions, e.g. boom lighting, traffic lights, electromagnet



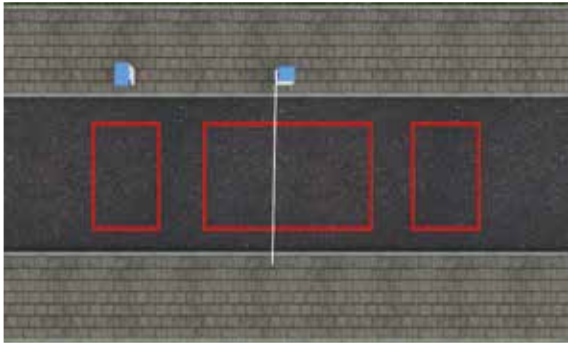

Induction loops

- ✓ 3 integrated loop detectors
- ✓ Many configuration options

Further information can be found on page 40/41.



Laser scanner

- ✓ Efficient protection of persons and vehicles
- ✓ TÜV-certified as personal protection device

Further information can be found on page 42/43.

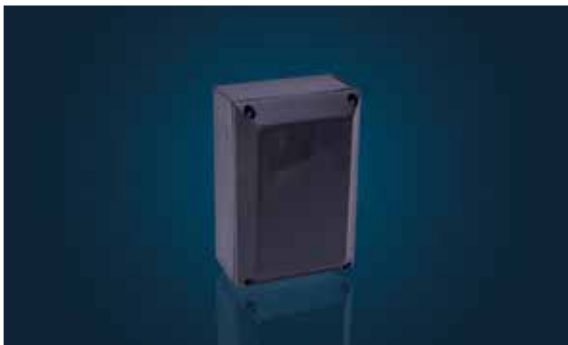

Photoelectric barrier

- ✓ Transmitter and receiver
- ✓ Range 18m



Lights

- ✓ Traffic lights available in green or red
- ✓ Flashing lights as warning devices

INDUCTION LOOPS



Induction loops

6m / 8m / 10m / 12m / 16m / 21m perimeter with 12m lead. Optionally with 2.5kg compound in black or grey.



Pre-assembled induction loop

Complete assembled induction loop, ready for immediate use. For underfloor installation (cobble, screed, concrete, asphalt). Including resistant PVC-pipe for protection. Approx. 1,800mm x 600mm with 10m lead. Special dimensions upon request.

Note

Three 1-channel loop detectors are integrated on the controller MO 24, which can be configured comfortably directly on the controller as well as via the PC software Easy-Control or ELKA ECON APP. A total of 8 modes are already preconfigured.

Configuration examples

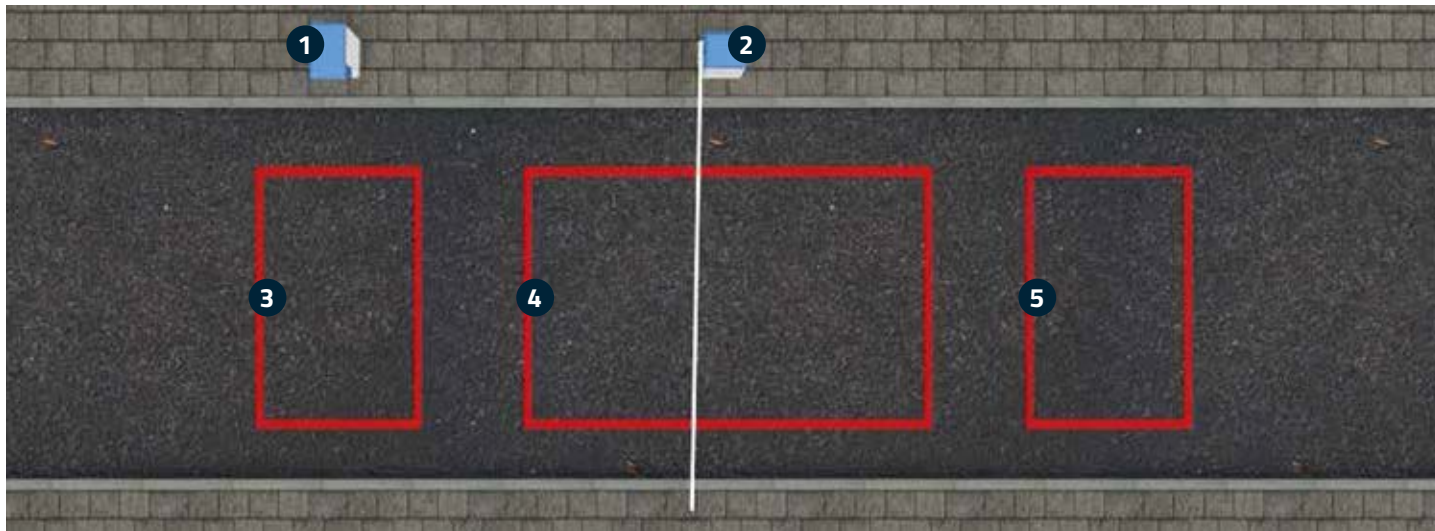

(1) Housing with entry control

(2) Barrier

(3) Presence loop

(4) Induction loop for securing vehicles

(5) Opening loop for automatic exit

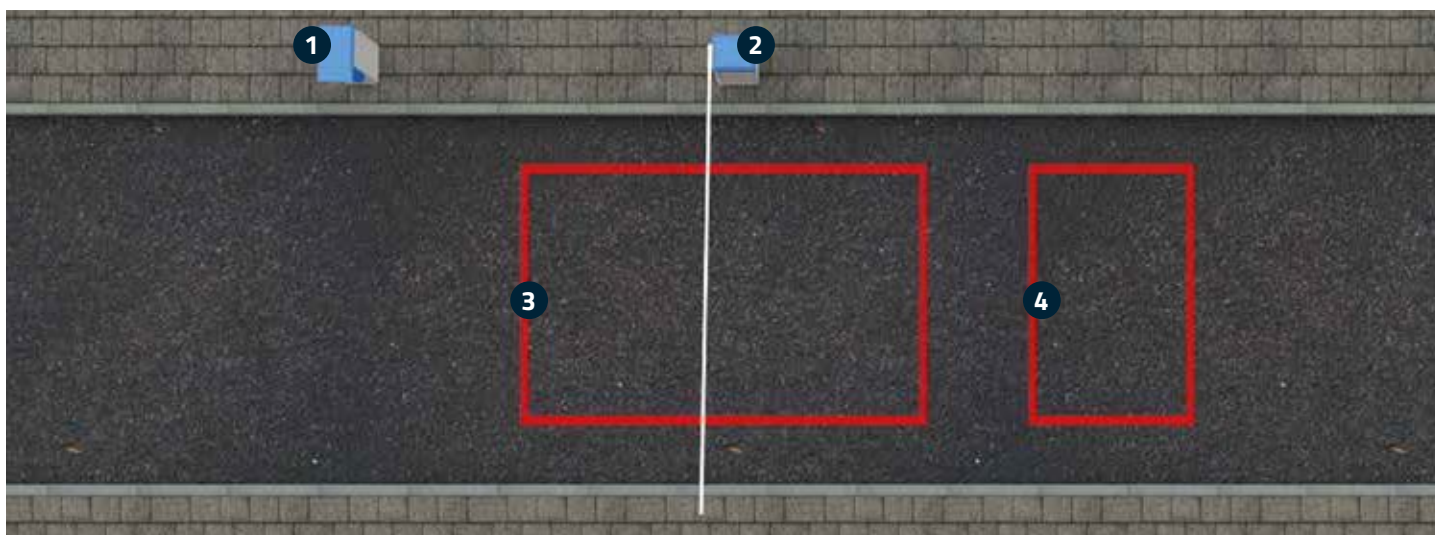

(1) Housing with exit control

(2) Barrier

(3) Induction loop for securing vehicles

(4) Opening loop for automatic exit

LASER SCANNER

For the safe detection of vehicles and persons during barrier operation where personal traffic cannot be excluded. The TÜV-certified protection device provides a reliable usage in case no induction loop can be used due to structural conditions. Pedestrian detection can be deactivated (during opening).



Laser scanner for free-standing installation

Laser scanner in a free-standing pillar for a monitoring field on the left and right side of the barrier boom with reference posts, available in two sizes. A reference post with reflector foil is required if no wall with reflector foil can be used as a reference object.



Laser scanner for mounting on the barrier housing

Laser scanner in a housing for a monitoring field on the left and right side of the barrier boom. For on-site installation on the barrier housing. A fixed post with reflector foil is required if no wall with reflector foil can be used as a reference object.

Note

Housings, pillars and posts optionally available in all RAL custom colours (extra charge).

Configuration example 1: series PARKING

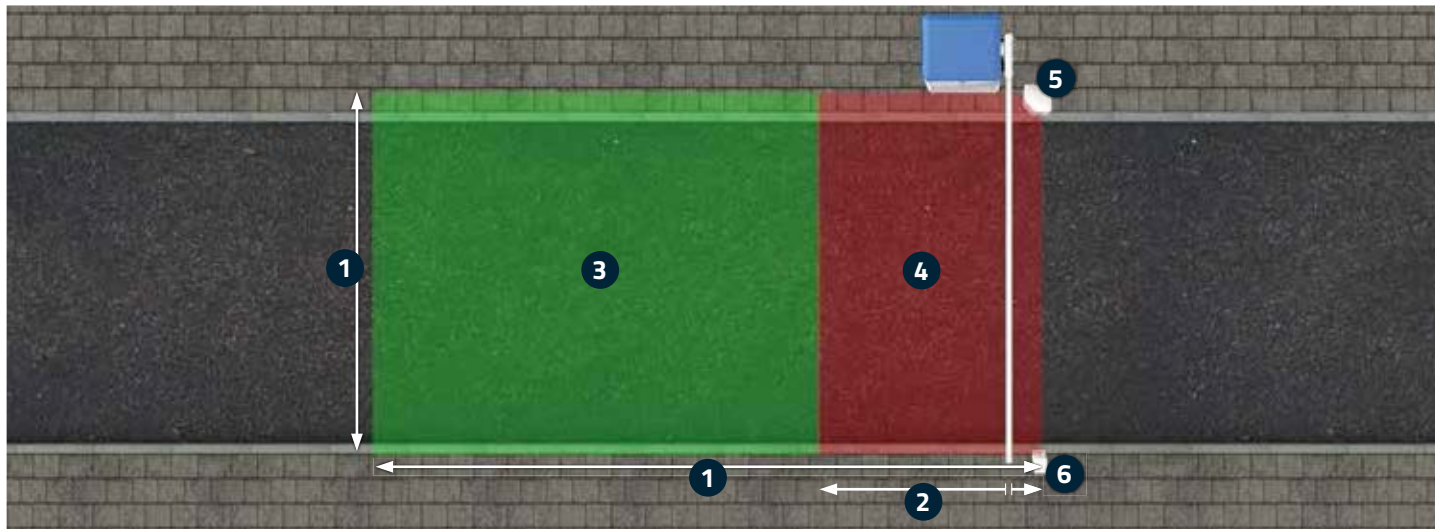

(1) Field dimension max. 9,900mm

(2) Security area, min. 200mm to the barrier boom

(3) Opening field

(4) Security field

(5) Laser scanner in free-standing pillar

(6) Reference post with reflector foil

Configuration example 2: series INDUSTRIAL with folding skirt or folding top and bottom skirt

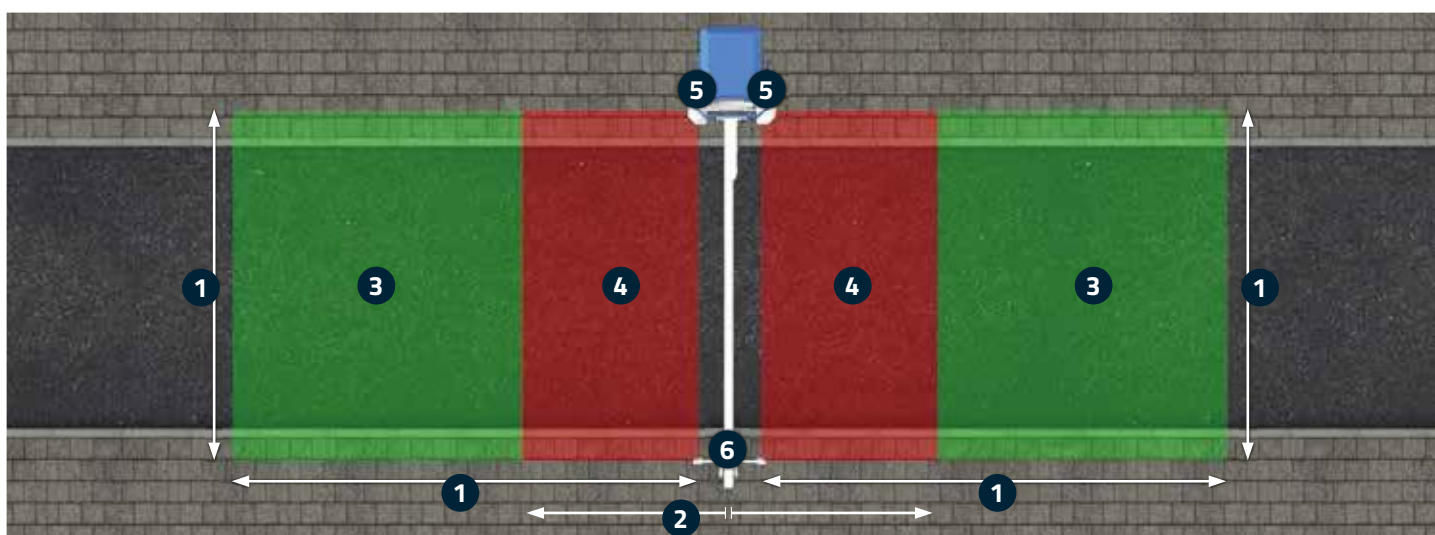

(1) Field dimension max. 9,900mm

(2) Security area, distance max. 200mm from the barrier boom

(3) Opening field

(4) Security field

(5) Laser scanner in housing, mounted on barrier housing

(6) Fixed post with reflector foil

ACCESS CONTROL DEVICES



ELKA



Radio remote control

- ✓ 1-, 2- or 4-channel, 434MHz or 868MHz
- ✓ Codable, very good range
- ✓ Upon request with your own logo (extra charge)



Dektop panels

- ✓ Single, double, triple or quadruple keyboard
- ✓ With illuminated keys
- ✓ OPEN / CLOSE / STOP / ON-OFF



Switches

- ✓ Key switches including key, flush or surface mounting
- ✓ Code switches with foil keypad or stainless steel keypad



RFID

- ✓ Contactless card reader
- ✓ For up to 1,000 transponder-cards
- ✓ One decoder communicates with up to three readers

You can find further access controls in our price list

Software for configuration and control of ELKA barriers

Programming, operation and control of ELKA barriers with controller MO 24 or MO 64 „Plus“ - comfortable via PC.



Easy Control Operator - the right software for porters

- ✓ Monitor up to 16 barriers with one PC
- ✓ The operating elements can be adjusted individually
- ✓ Status messages can be sent automatically as e-mail or SMS
- ✓ Photos can be recorded via a connected IP-camera during status changes
- ✓ Control all barriers automatically via a yearly timer (extra charge)
- ✓ The differential counting informs you how many parking spaces are free or occupied (extra charge)



Easy Control Configurator - during testing and for the installer on site

- ✓ Configure ELKA-barriers in your office, on site or by remote service
- ✓ Analyse incoming signals, messages and loop frequencies
- ✓ Record all settings for your documentation
- ✓ Create backups of the barrier configuration
- ✓ The integrated project administration assists in overview and planning of barrier systems
- ✓ The software records all status changes of the connected barriers during operation



App for programming and controlling of ELKA barriers

Programming, operation and control of ELKA barriers with controller MO 24 and MO 64 „Plus“ - comfortable via mobile phone, tablet or PC. Only usable in combination with the ELKA ECON BOX.

Quick set-up

Configuration, monitoring and control, simple project management and backup of all settings.

Professional maintenance

Analysing of the induction loops, error memory, service- and diagnostic report, diagnosis of all inputs and outputs of the controller.

Comfortable

Notification and control of events in case of a status change, user management, 365-day-timer, differential counter.



- (1) Hinged hood
- (2) Example installation: card reader
- (3) Example installation: intercom system
- (4) Lockable lateral access panel
- (5) Comfortable housing



ELKA pillars and housings made of aluminium

Pillars in different sizes, with one or two front panels, for photoelectric barriers, key switches, magnetic key readers, code switches or card readers. It is installed in the removable, lockable front panel.

Housings in different sizes, with one or two front panels, for various access controls and intercom systems. It is installed in the lockable lateral access panel and the hinged hood.

Pillars (w x d x h)

No.	Dimensions	Assembly dimensions
1	100 x 80 x 550mm	80 x 75 x 160mm
2	100 x 80 x 1,100mm	80 x 75 x 160mm
3	100 x 80 x 1,100mm	80 x 75 x 160mm
3a	100 x 80 x 1,850mm	80 x 75 x 160mm, top 70 x 75 x 160mm, bottom
4	145 x 145 x 1,100mm	130 x 125 x 160mm

Housings (w x d x h)

No.	Dimensions	Assembly dimensions
5	300 x 350 x 1,100mm	250 x 330 x 195mm
6	450 x 400 x 1,220mm	400 x 490 x 265mm
7	300 x 350 x 1,850mm	250 x 330 x 195mm
8	300 x 350 x 2,250mm	250 x 330 x 195mm, top 220 x 340 x 220mm, bottom

TECHNICAL DATA PARKING

Type	P 2500	P 3000	P 3500	P 4000	P 5000
Housing dimensions (w/d/h) (mm)	360 x 300 x 1,100				
Boom length (mm)	2,500	3,000	3,500	4,000	5,000
Effective boom length approx. (mm)	2,280	2,780	3,280	3,780	4,780
Running time approx. (s)	0.9 / 1.3 / 2.5	1.3 / 1.8 / 2.5	1.8 / 2.5 / 3.8	2.8 / 3.8 / 4.5	3.8 / 4.5 / 5.5
Duty cycle	100%				
Temperature range	-20°C up to +50°				
Degree of protection	IP54				
Supply voltage	110V - 240V, 50Hz - 60Hz				
Current consumption	max. 1.4A (230VAC) / max. 2.8A (115VAC)				
Weight without boom approx. (kg)	57	58	58	59	60
Boom weight approx. (kg)	3.8	4.5	5.0	5.8	10.0

We reserve the right to make technical alterations.

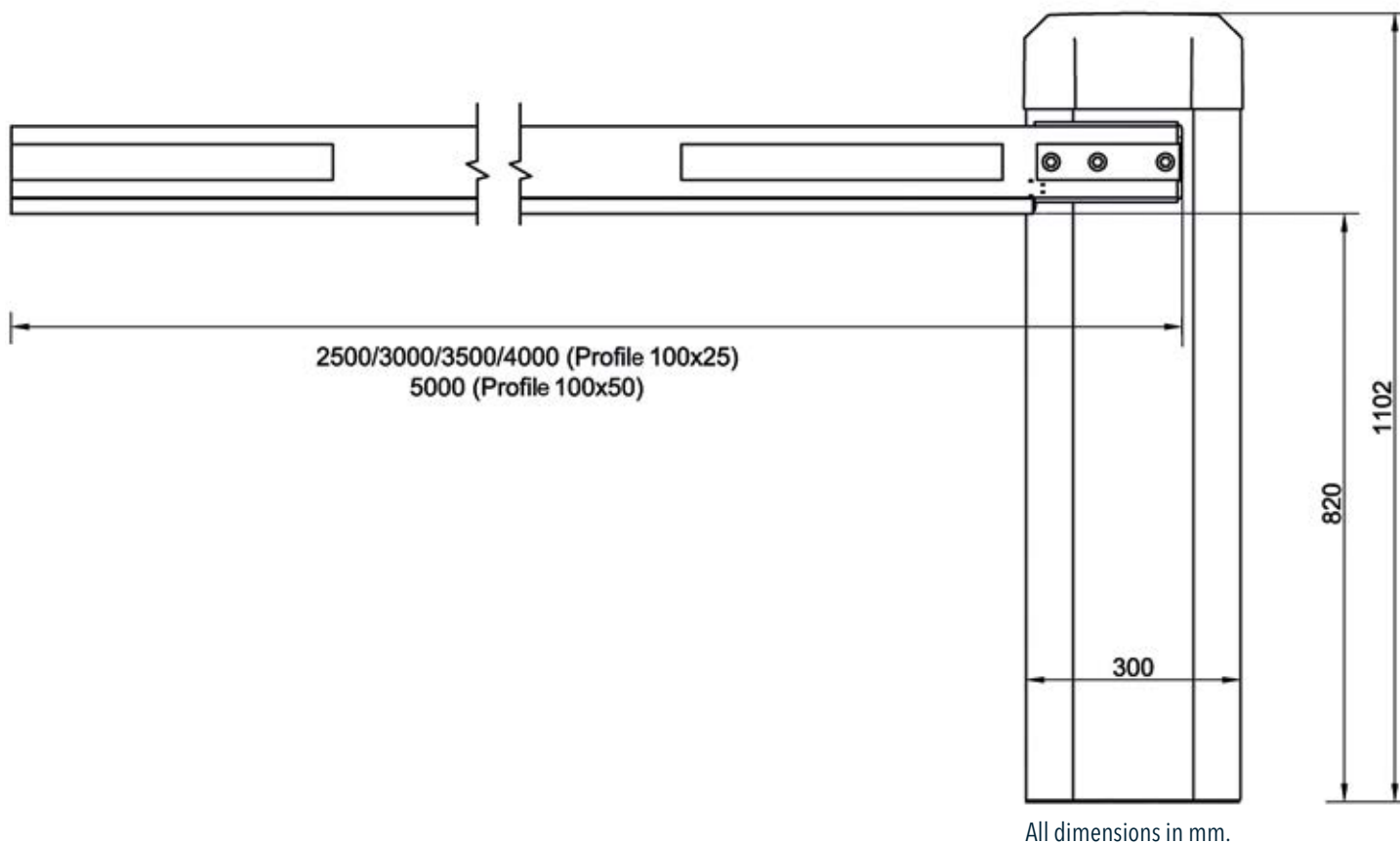

EQUIPMENT PARKING

Standard equipment	P 2500	P 3000	P 3500	P 4000	P 5000
Standard colours	Housing white / RAL 9010, housing hood blue / RAL 5012				
Boom connector	left / right usable				
Boom dimensions h/w (mm)	100 x 25			100 x 50	
Controller	MO 24 with 4x7-segment-display				
Power reversal	connectable				
Terminal row	prewired				
1-channel loop detector	3 integrated				
Multifunctional relay	6 integrated (e.g. for traffic lights, boom lighting LED, etc.)				
Electronic speed control	yes				
Dead man's mode	yes				
Antenna connection	yes				

Special equipment	P 2500	P 3000	P 3500	P 4000	P 5000
Articulation kit*	optional			no	
Round barrier boom	optional, \varnothing 60mm			no	
Fixed and swinging support	no		optional		mandatory
Boom lighting*	as LED strip in the rubber tube on the underside of the boom or mounted on the boom				
Contact „boom missing“	optional			no	
Custom colours	optionally available in all RAL custom colours (extra charge)				
Photoelectric barrier	optional				
Laser scanner	optional, free-standing installation or mounting on the barrier housing				
24V loading module	optional, uninterrupted barrier operation in case of a power failure (on-site batteries required)				
Automatic OPENING	optional, in case of power failure				
Radio remote control receiver	optional (socket available)				
Weekly timer / yearly timer	optional				
TCP-IP-module	optional (socket available)				
Multifunctional relay	optional module with: 8 additional multifunctional relays (AMR8) / 4 additional multifunctional relays (AMR4)				
Access control	Key switch, code switch, etc.				

* not available for round barrier booms

Type	S 5000	S 6000	S 8000
Housing dimensions (w/d/h) (mm)	400 x 450 x 1,073		
Boom length (mm)	5,000	6,000	8,000
Effective boom length approx. (mm)	5,170	6,170	8,170
Running time approx. (s)	4.0 / 5.5 / 7.0	5.0 / 6.5 / 8.0	7.0 / 8.5 / 10.0
Duty cycle	100%		
Temperature range	-20°C up to +50°		
Degree of protection	IP54		
Supply voltage	110V - 240V, 50Hz - 60Hz		
Current consumption	max. 1.4A (230VAC) / max. 2.8A (115VAC)		
Weight without boom approx. (kg)	121	129	134
Boom weight approx. (kg)	10	16	22

We reserve the right to make technical alterations.

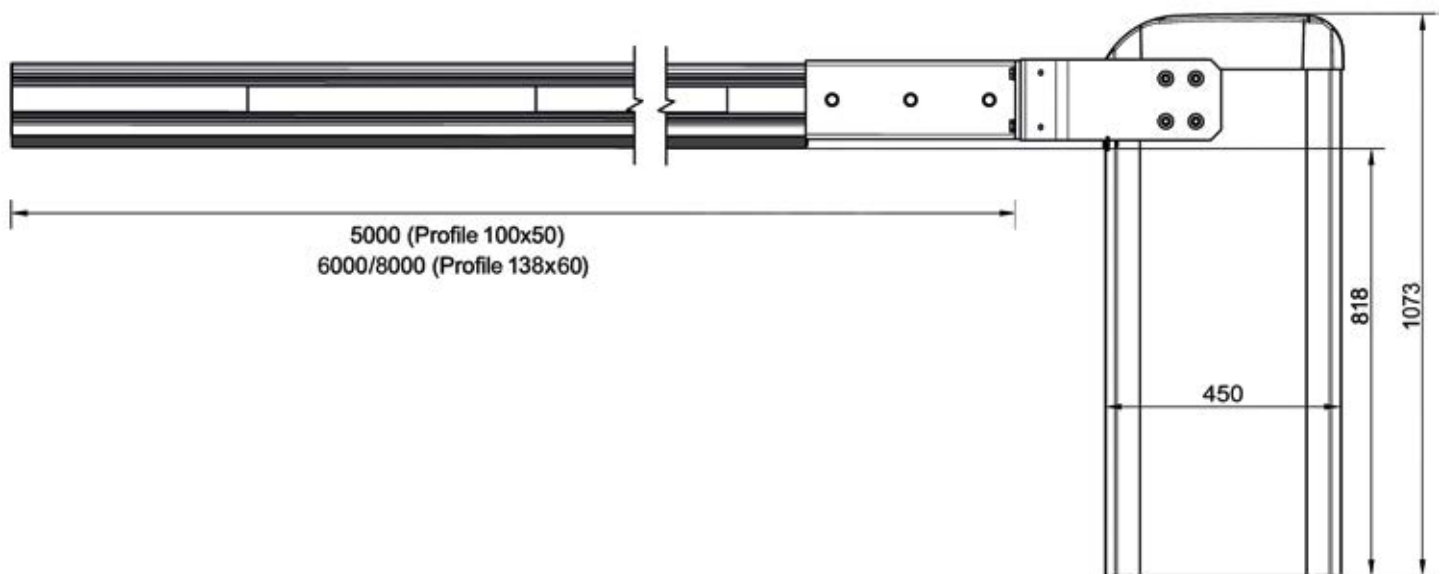

All dimensions in mm.

Standard equipment	S 5000	S 6000	S 8000
Standard colours	Housing and double wing white / RAL 9010, Housing hood blue / RAL 5012		
Boom connector	Double wing with middle boom connector		
Boom dimensions h/w (mm)	100 x 50	138 x 60	
Controller	MO 24 with 4x7-segment-display		
Power reversal	connectable		
Terminal row	prewired		
1-channel loop detector	3 integrated		
Multifunctional relay	6 integrated (e.g. for traffic lights, boom lighting LED, etc.)		
Electronic speed control	yes		
Dead man's mode	yes		
Antenna connection	yes		

Special equipment	S 5000	S 6000	S 8000
Articulation kit*	optional		no
Round barrier boom	optional, \varnothing 100mm		
Fixed and swinging support	optional		
Folding skirts and folding top and bottom skirts*	HG 75	HG 75 (up to 6,000mm), HG 150, SG 150 (up to 4,500mm)	HG 75 (up to 8,000mm), HG 150, SG 150 (up to 6,000mm)
Boom lighting*	mounted on the boom		
Custom colours	optionally available in all RAL custom colours (extra charge)		
Photoelectric barrier	optional		
Laser scanner	optional, free-standing installation or mounting on the barrier housing (two laser scanners are required when using folding skirts or folding top and bottom skirts)		
24V loading module	optional, uninterrupted barrier operation in case of a power failure (on-site batteries required)		
Automatic OPENING	optional		
Radio remote control receiver	optional (socket available)		
Weekly timer / yearly timer	optional		
TCP-IP-module	optional (socket available)		
Multifunctional relay	optional module with: 8 additional multifunctional relays (AMR8) / 4 additional multifunctional relays (AMR4)		
Access control	Key switch, code switch, etc.		

* not for round barrier boom

We reserve the right to make technical alterations.

TECHNICAL DATA TOLL

Type	T 1500	T 3000	T 3500
Housing dimensions (w/d/h) (mm)	360 x 300 x 1,100		
Boom length (mm)	1,500	3,240	3,740
Effective boom length approx. (mm)	1,260	3,000	3,500
Running time approx. (s)	0.3	0.6 / 0.9	0.9 / 1.3
Duty cycle	100%		
Temperature range	-20°C up to +50°		
Degree of protection	IP54		
Supply voltage	110V - 240V, 50Hz - 60Hz		
Current consumption	max. 1.4A (230VAC) / max. 2.8A (115VAC)		
Weight without boom approx. (kg)	56	58	58
Boom weight approx. (kg)	1.3	2.6	3.0

We reserve the right to make technical alterations.

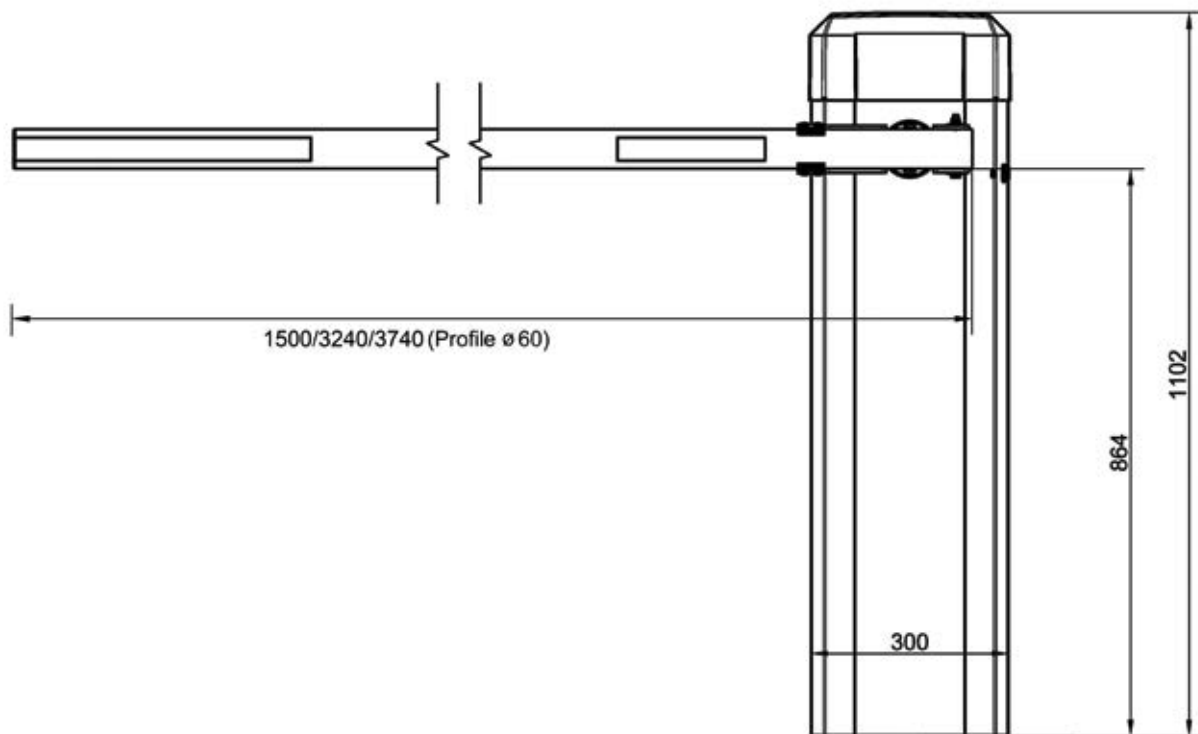

All dimensions in mm.

EQUIPMENT TOLL

Standard equipment	T 1500	T 3000	T 3500
Standard colours	Housing white / RAL 9010, housing hood blue / RAL 5012		
Boom connector	Round boom connector, left / right usable		
Boom dimensions h/w (mm)	Round boom with soft protect, \varnothing 60mm		
Controller	MO 24 with 4x7-segment-display		
Power reversal	connectable		
Terminal row	prewired		
1-channel loop detector	3 integrated		
Multifunctional relay	6 integrated (e.g. for traffic lights, boom lighting LED, etc.)		
Electronic speed control	yes		
Dead man's mode	yes		
Antenna connection	yes		

Special equipment	T 1500	T 3000	T 3500
Articulation kit	no		
Fixed and swinging support	no		
Contact „boom missing“	optional		
Custom colours	optionally available in all RAL custom colours (extra charge)		
Photoelectric barrier	optional		
Laser scanner	optional, free-standing installation or mounting on the barrier housing		
24V loading module	optional, uninterrupted barrier operation in case of a power failure (on-site batteries required)		
Automatic OPENING	optional, in case of power failure		
Radio remote control receiver	optional (socket available)		
Weekly timer / yearly timer	optional		
TCP-IP-module	optional (socket available)		
Multifunctional relay	optional module with: 8 additional multifunctional relays (AMR8) / 4 additional multifunctional relays (AMR4)		

TECHNICAL DATA SOLAR

Type	P 3700S Mobile	P 3700S Stationary
Housing dimensions (w/d/h) (mm)	360 x 300 x 1,100	
Boom length (mm)	3,700	
Effective boom length approx. (mm)	3,480	
Running time approx. (s)	3.8 / 4.5 / 5.5	
Solar module (w/d/h) (mm)	1,580 x 35 x 808	
Solar module incl. stand (w/d/h) (mm)	450 x 450 x 1,840 - 2,960	
Outdoor battery box (w/d/h) (mm)	580 x 480 x 390	
Concrete foundation (w/d/h) (mm)	1,200 x 300 x 800	-
Duty cycle*	100% (according to battery capacity)	
Temperature range	-15°C up to +40°	
Degree of protection	IP54	
Supply voltage	180 - 265V, 45Hz - 65Hz (for optional available charger)	
Nominal voltage solar module	24V DC	
Nominal power solar module	195Wp	
Nominal capacity batteries	150Ah / 24V	
Weight without boom approx. (kg)	70	
Boom weight approx. (kg)	9	
Solar module incl. stand weight approx. (kg)	61	
Outdoor battery box weight (incl. batteries) approx. (kg)	100	
Concrete foundation weight approx. (kg)	400	-

* With little solar radiation, the battery charge is sufficient for approx. 7 days with 500 cycles per day.

We reserve the right to make technical alterations.

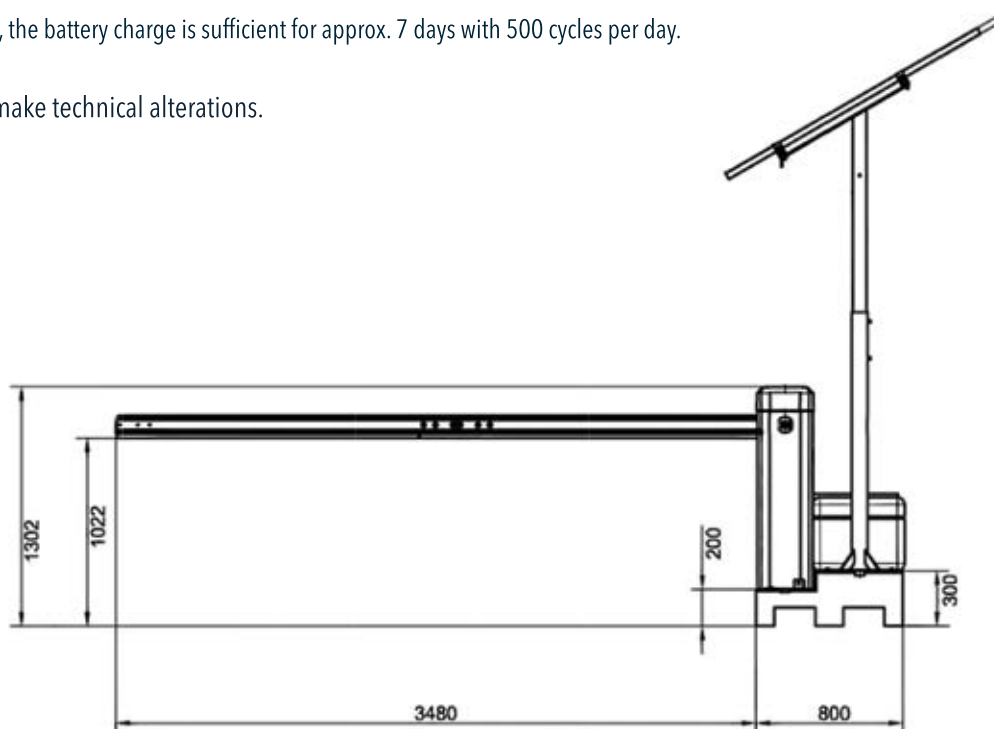

All dimensions in mm.

Standard equipment	P 3700S Mobile	P 3700S Stationary
Standard colours	Housing white / RAL 9010, housing hood blue / RAL 5012	
Boom connector	left / right usable	
Boom dimensions h/w (mm)	100 x 50	
Controller	MO 24 with 4x7-segment-display	
Power reversal	connectable	
Terminal row	prewired	
1-channel loop detector	3 integrated	
Multifunctional relay	6 integrated (e.g. for traffic lights, boom lighting LED, etc.)	
Electronic speed control	yes	
Dead man's mode	yes	
Antenna connection	yes	

Special equipment	P 3700S Mobile	P 3700S Stationary
Round barrier boom	optional, \varnothing 60mm	
Fixed and swinging support	no	optional
Boom lighting*	mounted on the boom (not for round boom)	
Contact „boom missing“	optional	
Custom colours	optionally available in all RAL custom colours (extra charge)	
Photoelectric barrier*	optional	
Laser scanner*	optional, free-standing installation or mounting on the barrier housing	
Radio remote control receiver*	optional (socket available)	
TCP-IP-module*	optional (socket available)	
Multifunctional relay	optional module with: 8 additional multifunctional relays (AMR8) / 4 additional multifunctional relays (AMR4)	
Access control*	Key switch, code switch, etc.	

* Additional consumers reduce the number of cycles and the standby time according to the amount of sunlight.

ON THE SAFE SIDE



Operation of legal and standard-compliant barriers

ELKA barriers of the PARKING, INDUSTRIAL and TOLL series are offered in two versions - EU and UL version, according to the requirements of the European Union and North America (USA, Canada).

For the EU version there is a declaration of conformity according to the machine directive, a declaration of performance according to the Construction Products Regulation and a TÜV certification according to the European standards. As part of the certification process, the TÜV tests the impact forces and the wind load class, among other things. For all barriers of the PARKING and INDUSTRIAL series (without folding skirts or folding top and bottom skirts) the impact forces specified in the standards are maintained at at least one of the three selectable running times. The operation of these barriers is therefore permitted wherever passenger traffic cannot be excluded for structural reasons. A prerequisite for this is that the safety devices prescribed during installation are installed.

If faster running times are required, the barrier system must be protected with a safety device according to standards. ELKA offers a laser scanner in a suitable housing in its range of accessories.

For the North American and Canadian market ELKA complies with the corresponding UL and CSA standards. Certification is carried out by the internationally active company Intertek, which carries out quarterly inspections on production site at ELKA in Tönning.

ELKA creates the prerequisite that operators and commissioning engineers are always on the safe side when it comes to questions of liability.

Inhouse-Seminars

Gate openers- and barrier seminar with expert certificate.

According to legal regulations, power-operated gate and barrier systems must be checked at least once a year. Only experts with a valid certificate are authorized to carry out the inspection and documentation. ELKA supports its partners in this and offers further training in its own premises in Tönning.

The ELKA team is looking forward to your questions and registrations:

akademie@elka.eu

ELKA TORANTRIEBE

PARTNER WITH COMPETENCE



ELKA

ELKA is a German manufacturer of gate openers and barrier systems of high quality with an experience of more than 40 years. We place a great value on high quality components, easy installation and customerfriendly service. „Partner with competence“- the management as well as the employees feel committed to this philosophy. ELKA stands for individual customer service. Fast order processing, short delivery times and adherence to deadlines are a matter of course for us. Our technicians at the service telephone know all products in detail and assist you during the planning of your projects. We are looking forward to your enquiries.

- ✓ Competent support
- ✓ Short delivery times and adherence to delivery dates
- ✓ Quality „Made in Germany“





We develop products for our customers. We have the highest demands on quality, functionality and comfort. Early in the development phase, suppliers, production department and customers are involved in the development process. All ELKA products are constantly supervised by the product development department and are continuously developed and improved – also after product market launch.

✓ In-house product development

✓ Support beyond development

✓ TÜV-tested products

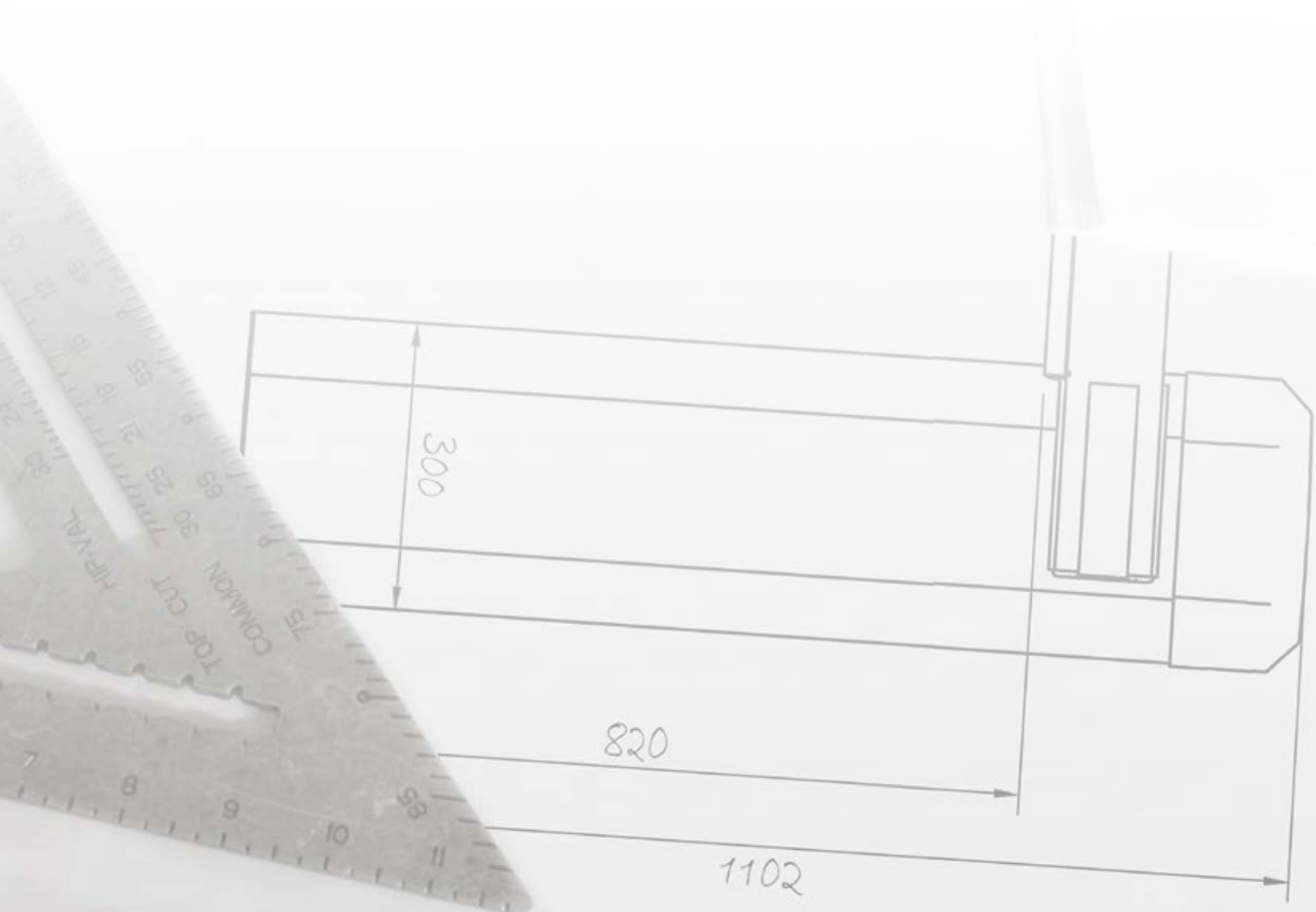

QUALITY TO THE LAST DETAIL



ELKA

We meet our high quality standards through the use of high-quality materials and coordinated components. All goods received are controlled at delivery on quality and technical specifications and are tested by using a 3D coordinate measuring machine. This enables us to guarantee precisely fitting components and an optimal installation process. Our production processes are regularly monitored. It goes without saying that every product is subjected to a comprehensive final inspection and functional tests before delivery.

- ✓ Precisely incoming goods inspection
- ✓ Supervised production processes
- ✓ Final inspections and functional tests





ELKA delivers products worldwide to more than 80 countries and supports the customers in three languages. Technically trained specialists and engineers respond individually to customer needs. For more than 40 years ELKA stands for a professional order processing, short delivery times and adherence to delivery times – benefit from our experience and take part in one of our technical training courses. Visit us at our factory in Tönning or at one of the trade fairs worldwide where ELKA exhibits.

Further information can be found on our website: www.elka.eu

- ✓ Personal customer service
- ✓ Professional order processing
- ✓ Individual shipping organization





You can find further ELKA barrier systems on our website

ELKA

ELKA-Torantriebe GmbH u. Co. Betriebs KG
Dithmarscher Str. 9, 25832 Tönning, Germany

✉ info@elka.eu

☎ +49(0)4861-9690-0

🌐 www.elka.eu

📠 +49(0)4861-9690-90